

Data sheet | Item number: 280-624/281-434

Component terminal block; 4-conductor; LED (red); 24 VDC; for DIN-rail 35 x 15 and 35 x 7.5; 2.5 mm²; CAGE CLAMP®

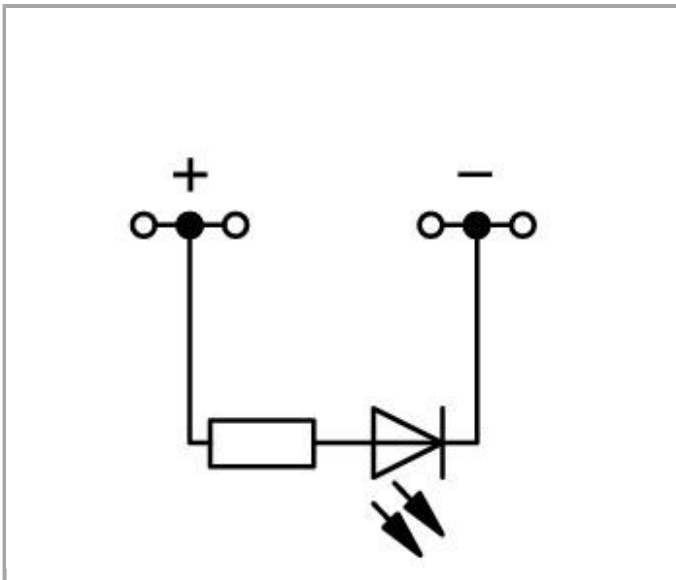

280-624/281-434

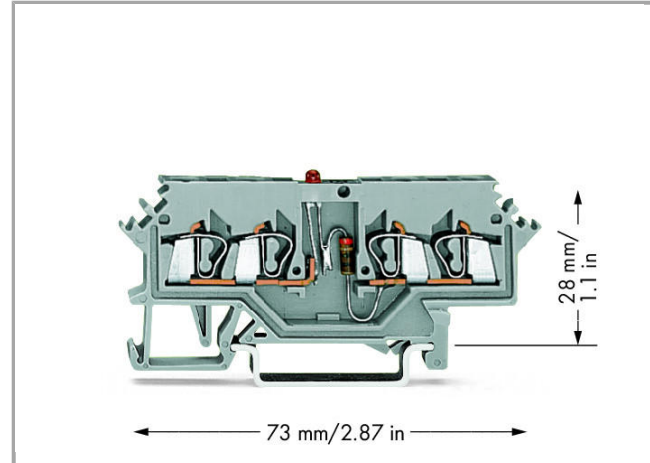
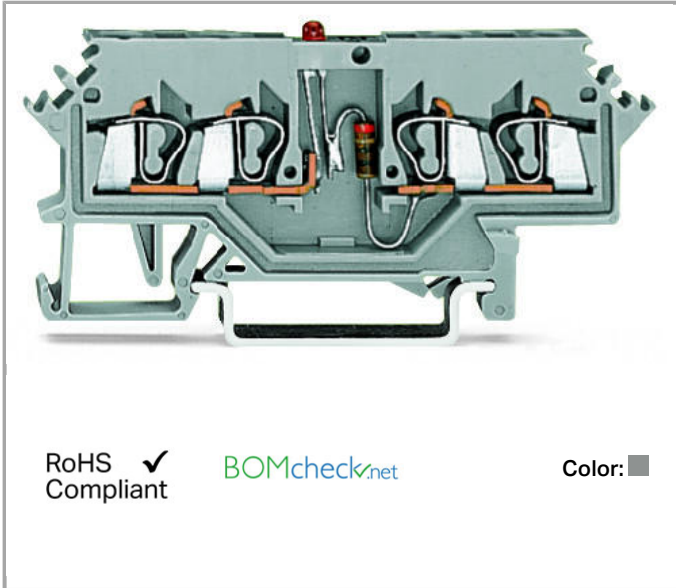

Item description

Note:

Terminating Aluminum Conductors

WAGO spring clamp terminal blocks are suitable for solid aluminum conductors up to 4 mm²/12 AWG if WAGO "Alu-Plus" Contact Paste is used for termination.

"Alu-Plus" Contact Paste Advantages:

- Automatically destroys the oxide film during clamping.

—



- Prevents fresh oxidation at the clamping point.
- Prevents electrolytic corrosion between aluminum and copper conductors (in the same terminal block).
- Provides long-term protection against corrosion.

Using terminal blocks with CAGE CLAMP® Spring Pressure Connection Technology, **aluminum conductors must first be cleaned with a blade and then immediately be inserted into the clamping units filled with "Alu-Plus" Contact Paste.**

It is also possible to apply WAGO "Alu-Plus" **additionally** on the whole surface of the aluminum conductor before termination.

Please note that the nominal currents must be adapted to the reduced conductivity of the aluminum conductors:

2.5 mm² (14 AWG) = 16 A

4 mm² (12 AWG) = 22 A

Data

Electrical data

Voltage type (1)	DC
Nominal voltage	24 V

Ratings per IEC/EN 60664-1

Rated current	0.025 A
---------------	---------

Connection data

Connection technology	CAGE CLAMP®
Actuation type	Operating tool
Connectable conductor materials	Copper Aluminum
Solid conductor	0.08 ... 2.5 mm ² / 28 ... 14 AWG
Fine-stranded conductor	0.08 ... 2.5 mm ² / 28 ... 14 AWG
Strip length	8 ... 9 mm / 0.31 ... 0.35 inch
Total number of connection points	4
Total number of potentials	1
Number of levels	1
Type of wiring	Front-entry wiring

Geometrical Data

Width	5 mm / 0.197 inch
Height from upper-edge of DIN-35 rail	28 mm / 1.102 inch
Depth	73 mm / 2.874 inch

Mechanical data

Design	horizontal
Type of mounting	DIN-35 rail
Marking level	Side marking

Material Data

Color	gray
Insulating material	Polyamide 66 (PA 66)
Fire load	0.141 MJ
Weight	8.449 g

Commercial data

Product Group	1 (Rail Mounted Terminal Blocks)
Country of origin	DE
GTIN	4045454396589
Customs Tariff No.	85369010000

Approvals / Certificates

Country specific Approvals



Logo	Approval	Additional Approval Text	Certificate name
	CCA DEKRA Certification B.V.	EN 60947	2157201.01

Ship Approvals











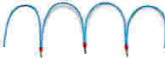

Logo	Approval	Additional Approval Text	Certificate name
	ABS American Bureau of Shipping	EN 60947	14- HG1293677- PDA

Compatible products

Insulation stop

	Item no.: 280-470 Insulation stop; 0.08 - 0.2 mm ² "s" (0.14 mm ² "f-st"); 5 pieces/strip	280-470
	Item no.: 280-471 Insulation stop; 0.25 - 0.5 mm ² ; 5 pieces/strip	280-471
	Item no.: 280-472 Insulation stop; 0.75 - 1 mm ² ; 5 pieces/strip	280-472

Jumper

	Item no.: 210-103 Wire commoning chain; insulated; 50 connections	210-103
	Item no.: 210-123 Wire commoning chain; insulated; 50 connections	210-123
	Item no.: 249-123 Push-in type wire jumper; insulated; wire length 180 mm; Conductor cross section 0.75 mm ²	249-123
	Item no.: 249-125 Push-in type wire jumper; insulated; wire length 60 mm; Conductor cross section 0.75 mm ²	249-125
	Item no.: 249-126 Push-in type wire jumper; insulated; wire length 110 mm; Conductor cross section 0.75 mm ²	249-126
	Item no.: 249-127 Push-in type wire jumper; insulated; wire length 250 mm; Conductor cross section 0.75 mm ²	249-127
	Item no.: 280-482 Comb-style jumper bar; insulated; 2-way; IN = IN terminal block	280-482
	Item no.: 280-483 Comb-style jumper bar; insulated; 3-way; IN = IN terminal block	280-483
	Item no.: 280-484 Comb-style jumper bar; insulated; 4-way; IN = IN terminal block	280-484
	Item no.: 280-485 Comb-style jumper bar; insulated; 5-way; IN = IN terminal block	280-485
	Item no.: 280-490 Comb-style jumper bar; insulated; 10-way; IN = IN terminal block	280-490
	Item no.: 280-492 Alternate comb-style jumper bar; insulated; 2-way; IN = IN terminal block	280-492
	Item no.: 709-110 Wire commoning chain; insulated; 4 connections; 3 x 110 mm	709-110
	Item no.: 709-111 Wire commoning chain; insulated; 3 connections; 2 x 120 mm	709-111



Item no.: 709-112
Wire commoning chain; insulated; 3 connections; 2 x 170 mm

709-112

General accessories



Item no.: 231-162/003-000
Male connector for rail-mount terminal blocks; 1.2 x 1.2 mm pins; straight; Pin spacing 5 mm; 2-pole / 003-000

231-162



Item no.: 231-163/003-000
Male connector for rail-mount terminal blocks; 1.2 x 1.2 mm pins; straight; Pin spacing 5 mm; 3-pole / 003-000

231-163



Item no.: 231-164/003-000
Male connector for rail-mount terminal blocks; 1.2 x 1.2 mm pins; straight; Pin spacing 5 mm; 4-pole / 003-000

231-164



Item no.: 231-165/003-000
Male connector for rail-mount terminal blocks; 1.2 x 1.2 mm pins; straight; Pin spacing 5 mm; 5-pole / 003-000

231-165



Item no.: 231-166/003-000
Male connector for rail-mount terminal blocks; 1.2 x 1.2 mm pins; straight; Pin spacing 5 mm; 6-pole / 003-000

231-166



Item no.: 231-167/003-000
Male connector for rail-mount terminal blocks; 1.2 x 1.2 mm pins; straight; Pin spacing 5 mm; 7-pole / 003-000

231-167



Item no.: 231-168/003-000
Male connector for rail-mount terminal blocks; 1.2 x 1.2 mm pins; straight; Pin spacing 5 mm; 8-pole / 003-000

231-168



Item no.: 231-169/003-000
Male connector for rail-mount terminal blocks; 1.2 x 1.2 mm pins; straight; Pin spacing 5 mm; 9-pole / 003-000

231-169



Item no.: 231-170/003-000
Male connector for rail-mount terminal blocks; 1.2 x 1.2 mm pins; straight; Pin spacing 5 mm; 10-pole / 003-000

231-170



Item no.: 231-171/003-000
Male connector for rail-mount terminal blocks; 1.2 x 1.2 mm pins; straight; Pin spacing 5 mm; 11-pole / 003-000

231-171



Item no.: 231-172/003-000
Male connector for rail-mount terminal blocks; 1.2 x 1.2 mm pins; straight; Pin spacing 5 mm; 12-pole / 003-000

231-172



Item no.: 231-176/003-000
Male connector for rail-mount terminal blocks; 1.2 x 1.2 mm pins; straight; Pin spacing 5 mm; 16-pole / 003-000

231-176

















Item no.: 231-180/003-000
Male connector for rail-mount terminal blocks; 1.2 x 1.2 mm pins; straight; Pin spacing 5 mm; 20-pole / 003-000















231-180

































Item no.: 231-668
Lockout caps; for covering unused clamping units

231-668

	Item no.: 231-669 Lockout caps; for covering unused clamping units	231-669
	Item no.: 249-105 Group marker carrier	249-105
Marking accessories		
	Item no.: 2009-115 WMB-Inline; for Smart Printer; on reel; stretchable 5 - 5.2 mm; plain; snap-on type	2009-115
	Item no.: 2009-115/000-002 WMB-Inline; for Smart Printer; on reel; stretchable 5 - 5.2 mm; plain; snap-on type	2009-115 /000-002
	Item no.: 2009-115/000-006 WMB-Inline; for smartPRINTER; on reel; stretchable 5 - 5.2 mm; plain; snap-on type	2009-115 /000-006
	Item no.: 2009-115/000-007 WMB-Inline; for Smart Printer; on reel; stretchable 5 - 5.2 mm; plain; snap-on type	2009-115 /000-007
	Item no.: 2009-115/000-012 WMB-Inline; for smartPRINTER; on reel; stretchable 5 - 5.2 mm; plain; snap-on type	2009-115 /000-012
	Item no.: 2009-115/000-017 WMB-Inline; for Smart Printer; on reel; stretchable 5 - 5.2 mm; plain; snap-on type	2009-115 /000-017
	Item no.: 2009-115/000-023 WMB-Inline; for Smart Printer; on reel; stretchable 5 - 5.2 mm; plain; snap-on type	2009-115 /000-023
	Item no.: 2009-115/000-024 WMB-Inline; for smartPRINTER; on reel; stretchable 5 - 5.2 mm; plain; snap-on type	2009-115 /000-024
	Item no.: 793-501 WMB marking card; as card; not stretchable; plain; snap-on type	793-501
	Item no.: 793-501/000-002 WMB marking card; as card; not stretchable; plain; snap-on type	793-501 /000-002
	Item no.: 793-501/000-005 WMB marking card; as card; not stretchable; plain; snap-on type	793-501 /000-005
	Item no.: 793-501/000-006 WMB marking card; as card; not stretchable; plain; snap-on type	793-501 /000-006
	Item no.: 793-501/000-007 WMB marking card; as card; not stretchable; plain; snap-on type	793-501 /000-007

	Item no.: 793-501/000-012 WMB marking card; as card; not stretchable; plain; snap-on type	/000-012	793-501
	Item no.: 793-501/000-017 WMB marking card; as card; not stretchable; plain; snap-on type	/000-017	793-501
	Item no.: 793-501/000-023 WMB marking card; as card; not stretchable; plain; snap-on type	/000-023	793-501
	Item no.: 793-501/000-024 WMB marking card; as card; not stretchable; plain; snap-on type	/000-024	793-501
	Item no.: 793-5501 WMB marking card; as card; for terminal block width 5 - 17.5 mm; stretchable 5 - 5.2 mm; plain; snap-on type		793-5501
	Item no.: 793-5501/000-002 WMB marking card; as card; for terminal block width 5 - 17.5 mm; stretchable 5 - 5.2 mm; plain; snap-on type	/000-002	793-5501
	Item no.: 793-5501/000-005 WMB marking card; as card; stretchable 5 - 5.2 mm; plain; snap-on type	/000-005	793-5501
	Item no.: 793-5501/000-006 WMB marking card; as card; stretchable 5 - 5.2 mm; plain; snap-on type	/000-006	793-5501
	Item no.: 793-5501/000-007 WMB marking card; as card; stretchable 5 - 5.2 mm; plain; snap-on type	/000-007	793-5501
	Item no.: 793-5501/000-012 WMB marking card; as card; stretchable 5 - 5.2 mm; plain; snap-on type	/000-012	793-5501
	Item no.: 793-5501/000-017 WMB marking card; as card; stretchable 5 - 5.2 mm; plain; snap-on type	/000-017	793-5501
	Item no.: 793-5501/000-023 WMB marking card; as card; stretchable 5 - 5.2 mm; plain; snap-on type	/000-023	793-5501
	Item no.: 793-5501/000-024 WMB marking card; as card; stretchable 5 - 5.2 mm; plain; snap-on type	/000-024	793-5501
Carrier rail			
	Item no.: 210-112 Steel carrier rail; 35 x 7.5 mm; 1 mm thick; 2 m long; slotted; according to EN 60715; "Hole width 25 mm		210-112
	Item no.: 210-113 Steel carrier rail; 35 x 7.5 mm; 1 mm thick; 2 m long; unslotted; according to EN 60715		210-113

	Item no.: 210-114 Steel carrier rail; 35 x 15 mm; 1.5 mm thick; 2 m long; unslotted; similar to EN 60715	210-114
	Item no.: 210-115 Steel carrier rail; 35 x 7.5 mm; 1 mm thick; 2 m long; slotted; according to EN 60715; "Hole width 18 mm	210-115
	Item no.: 210-118 Steel carrier rail; 35 x 15 mm; 2.3 mm thick; 2 m long; unslotted; according to EN 60715	210-118
	Item no.: 210-196 Aluminum carrier rail; 35 x 8.2 mm; 1.6 mm thick; 2 m long; unslotted; similar to EN 60715	210-196
	Item no.: 210-197 Steel carrier rail; 35 x 15 mm; 1.5 mm thick; 2 m long; slotted; similar to EN 60715	210-197
	Item no.: 210-198 Copper carrier rail; 35 x 15 mm; 2.3 mm thick; 2 m long; unslotted; according to EN 60715	210-198
	Item no.: 210-504 Steel carrier rail; 35 x 7.5 mm; 1 mm thick; 2 m long; slotted; galvanized; according to EN 60715	210-504
	Item no.: 210-505 Steel carrier rail; 35 x 7.5 mm; 1 mm thick; 2 m long; unslotted; galvanized; according to EN 60715	210-505
	Item no.: 210-506 Steel carrier rail; 35 x 15 mm; 1.5 mm thick; 2 m long; unslotted; galvanized; similar to EN 60715	210-506
	Item no.: 210-508 Steel carrier rail; 35 x 15 mm; 1.5 mm thick; 2 m long; slotted; galvanized; similar to EN 60715	210-508
Female plug		
	Item no.: 232-132/005-000 Female connector for rail-mount terminal blocks; straight; Pin spacing 5 mm; 2-pole	232-132 /005-000
	Item no.: 232-132/005-000/039-000 Female connector for rail-mount terminal blocks; straight; Locking lever; Pin spacing 5 mm; 3-pole	232-132 /005-000/039-000
	Item no.: 232-133/005-000 Female connector for rail-mount terminal blocks; straight; Pin spacing 5 mm; 3-pole	232-133 /005-000
	Item no.: 232-133/005-000/039-000 Female connector for rail-mount terminal blocks; straight; Locking lever; Pin spacing 5 mm; 3-pole	232-133 /005-000/039-000
	Item no.: 232-134/005-000 Female connector for rail-mount terminal blocks; straight; Pin spacing 5 mm; 4-pole	232-134 /005-000
	Item no.: 232-134/005-000/039-000 Female connector for rail-mount terminal blocks; straight; Locking lever; Pin spacing 5 mm; 4-pole	232-134 /005-000/039-000
	Item no.: 232-135/005-000 Female connector for rail-mount terminal blocks; straight; Pin spacing 5 mm; 5-pole	232-135 /005-000

	Item no.: 232-135/005-000/039-000 Female connector for rail-mount terminal blocks; straight; Locking lever; Pin spacing 5 mm; 5-pole	232-135 /005-000/039-000
	Item no.: 232-136/005-000 Female connector for rail-mount terminal blocks; straight; Pin spacing 5 mm; 6-pole	232-136 /005-000
	Item no.: 232-136/005-000/039-000 Female connector for rail-mount terminal blocks; straight; Locking lever; Pin spacing 5 mm; 6-pole	232-136 /005-000/039-000
	Item no.: 232-137/005-000 Female connector for rail-mount terminal blocks; straight; Pin spacing 5 mm; 7-pole	232-137 /005-000
	Item no.: 232-137/005-000/039-000 Female connector for rail-mount terminal blocks; straight; Locking lever; Pin spacing 5 mm; 7-pole	232-137 /005-000/039-000
	Item no.: 232-138/005-000 Female connector for rail-mount terminal blocks; straight; Pin spacing 5 mm; 8-pole	232-138 /005-000
	Item no.: 232-138/005-000/039-000 Female connector for rail-mount terminal blocks; straight; Locking lever; Pin spacing 5 mm; 8-pole	232-138 /005-000/039-000
	Item no.: 232-139/005-000 Female connector for rail-mount terminal blocks; straight; Pin spacing 5 mm; 9-pole	232-139 /005-000
	Item no.: 232-139/005-000/039-000 Female connector for rail-mount terminal blocks; straight; Locking lever; Pin spacing 5 mm; 9-pole	232-139 /005-000/039-000
	Item no.: 232-140/005-000 Female connector for rail-mount terminal blocks; straight; Pin spacing 5 mm; 10-pole	232-140 /005-000
	Item no.: 232-140/005-000/039-000 Female connector for rail-mount terminal blocks; straight; Locking lever; Pin spacing 5 mm; 10-pole	232-140 /005-000/039-000
	Item no.: 232-142/005-000 Female connector for rail-mount terminal blocks; straight; Pin spacing 5 mm; 12-pole	232-142 /005-000
	Item no.: 232-142/005-000/039-000 Female connector for rail-mount terminal blocks; straight; Locking lever; Pin spacing 5 mm; 12-pole	232-142 /005-000/039-000
	Item no.: 232-146/005-000 Female connector for rail-mount terminal blocks; straight; Pin spacing 5 mm; 16-pole	232-146 /005-000
	Item no.: 232-146/005-000/039-000 Female connector for rail-mount terminal blocks; straight; Locking lever; Pin spacing 5 mm; 16-pole	232-146 /005-000/039-000

**Item no.: 232-147/005-000/039-000**

Female connector for rail-mount terminal blocks; straight; Locking lever; Pin spacing 5 mm; 17-pole / 005-000/039-000

232-147

Item no.: 232-150/005-000

Female connector for rail-mount terminal blocks; straight; Pin spacing 5 mm; 20-pole / 005-000

232-150

Item no.: 232-150/005-000/039-000

Female connector for rail-mount terminal blocks; straight; Locking lever; Pin spacing 5 mm; 20-pole / 005-000/039-000

232-150

Item no.: 232-232/005-000

Female connector for rail-mount terminal blocks; angled; Pin spacing 5 mm; 2-pole / 005-000

232-232

Item no.: 232-232/005-000/039-000

Female connector for rail-mount terminal blocks; angled; Locking lever; Pin spacing 5 mm; 2-pole / 005-000/039-000

232-232

Item no.: 232-233/005-000

Female connector for rail-mount terminal blocks; angled; Pin spacing 5 mm; 3-pole / 005-000

232-233

Item no.: 232-233/005-000/039-000

Female connector for rail-mount terminal blocks; angled; Locking lever; Pin spacing 5 mm; 3-pole / 005-000/039-000

232-233

Item no.: 232-234/005-000

Female connector for rail-mount terminal blocks; angled; Pin spacing 5 mm; 4-pole / 005-000

232-234

Item no.: 232-234/005-000/039-000

Female connector for rail-mount terminal blocks; angled; Locking lever; Pin spacing 5 mm; 4-pole / 005-000/039-000

232-234

Item no.: 232-235/005-000

Female connector for rail-mount terminal blocks; angled; Pin spacing 5 mm; 5-pole / 005-000

232-235

Item no.: 232-235/005-000/039-000

Female connector for rail-mount terminal blocks; angled; Locking lever; Pin spacing 5 mm; 5-pole / 005-000/039-000

232-235

Item no.: 232-236/005-000

Female connector for rail-mount terminal blocks; angled; Pin spacing 5 mm; 6-pole / 005-000

232-236

Item no.: 232-236/005-000/039-000















Female connector for rail-mount terminal blocks; angled; Locking lever; Pin spacing 5 mm; 6-pole / 005-000/039-000















232-236















Item no.: 232-237/005-000















Female connector for rail-mount terminal blocks; straight; Pin spacing 5 mm; 7-pole / 005-000















232-237















	Item no.: 232-238/005-000 Female connector for rail-mount terminal blocks; angled; Pin spacing 5 mm; 8-pole	/005-000	232-238
	Item no.: 232-239/005-000 Female connector for rail-mount terminal blocks; angled; Pin spacing 5 mm; 9-pole	/005-000	232-239
	Item no.: 232-240/005-000 Female connector for rail-mount terminal blocks; angled; Pin spacing 5 mm; 10-pole	/005-000	232-240
	Item no.: 232-240/005-000/039-000 Female connector for rail-mount terminal blocks; angled; Locking lever; Pin spacing 5 mm; 10-pole	/005-000/039-000	232-240
	Item no.: 232-242/005-000 Female connector for rail-mount terminal blocks; angled; Pin spacing 5 mm; 12-pole	/005-000	232-242
	Item no.: 232-242/005-000/039-000 Female connector for rail-mount terminal blocks; angled; Locking lever; Pin spacing 5 mm; 12-pole	/005-000/039-000	232-242
	Item no.: 232-246/005-000 Female connector for rail-mount terminal blocks; angled; Pin spacing 5 mm; 16-pole	/005-000	232-246
	Item no.: 232-246/005-000/039-000 Female connector for rail-mount terminal blocks; angled; Locking lever; Pin spacing 5 mm; 16-pole	/005-000/039-000	232-246
	Item no.: 232-250/005-000 Female connector for rail-mount terminal blocks; angled; Pin spacing 5 mm; 20-pole	/005-000	232-250
	Item no.: 232-250/005-000/039-000 Female connector for rail-mount terminal blocks; angled; Locking lever; Pin spacing 5 mm; 20-pole	/005-000/039-000	232-250
	Item no.: 232-732/005-000 Female connector for rail-mount terminal blocks; straight; Pin spacing 7.5 mm; 2-pole	/005-000	232-732
	Item no.: 232-733/005-000 Female connector for rail-mount terminal blocks; straight; Pin spacing 7.5 mm; 3-pole	/005-000	232-733
	Item no.: 232-734/005-000 Female connector for rail-mount terminal blocks; straight; Pin spacing 7.5 mm; 4-pole	/005-000	232-734
	Item no.: 232-734/005-000/039-000 Female connector for rail-mount terminal blocks; straight; Pin spacing 7.5 mm; 4-pole	/005-000/039-000	232-734
	Item no.: 232-735/005-000 Female connector for rail-mount terminal blocks; straight; Pin spacing 7.5 mm; 5-pole	/005-000	232-735

















	Item no.: 232-735/005-000/039-000 Female connector for rail-mount terminal blocks; straight; Pin spacing 7.5 mm; 5-pole	232-735 /005-000/039-000
	Item no.: 232-736/005-000 Female connector for rail-mount terminal blocks; straight; Pin spacing 7.5 mm; 6-pole	232-736 /005-000
	Item no.: 232-736/005-000/039-000 Female connector for rail-mount terminal blocks; straight; Pin spacing 7.5 mm; 6-pole	232-736 /005-000/039-000
	Item no.: 232-738/005-000 Female connector for rail-mount terminal blocks; straight; Pin spacing 7.5 mm; 8-pole	232-738 /005-000
	Item no.: 232-740/005-000 Female connector for rail-mount terminal blocks; straight; Pin spacing 7.5 mm; 10-pole	232-740 /005-000
	Item no.: 232-742/005-000 Female connector for rail-mount terminal blocks; straight; Pin spacing 7.5 mm; 12-pole	232-742 /005-000
	Item no.: 232-832/005-000 Female connector for rail-mount terminal blocks; angled; Pin spacing 7.5 mm; 2-pole	232-832 /005-000
	Item no.: 232-833/005-000 Female connector for rail-mount terminal blocks; angled; Pin spacing 7.5 mm; 3-pole	232-833 /005-000
	Item no.: 232-834/005-000 Female connector for rail-mount terminal blocks; angled; Pin spacing 7.5 mm; 4-pole	232-834 /005-000
	Item no.: 232-836/005-000 Female connector for rail-mount terminal blocks; straight; Pin spacing 7.5 mm; 6-pole	232-836 /005-000
	Item no.: 232-836/005-000/039-000 Female connector for rail-mount terminal blocks; angled; Pin spacing 7.5 mm; 6-pole	232-836 /005-000/039-000
	Item no.: 232-840/005-000 Female connector for rail-mount terminal blocks; straight; Pin spacing 7.5 mm; 10-pole	232-840 /005-000
	Item no.: 232-842/005-000 Female connector for rail-mount terminal blocks; straight; Pin spacing 7.5 mm; 12-pole	232-842 /005-000
	Item no.: 722-132/005-000 Female connector for rail-mount terminal blocks; straight; 100% protected against mismatching; Pin spacing 5 mm; 2-pole	722-132 /005-000
	Item no.: 722-132/005-000/039-000	

	Female connector for rail-mount terminal blocks; straight; 100% protected against mismatching; Locking lever; Pin spacing 5 mm; 3-pole	722-132 /005-000/039-000
	Item no.: 722-133/005-000 Female connector for rail-mount terminal blocks; straight; 100% protected against mismatching; Pin spacing 5 mm; 3-pole	722-133 /005-000
	Item no.: 722-133/005-000/039-000 Female connector for rail-mount terminal blocks; straight; 100% protected against mismatching; Locking lever; Pin spacing 5 mm; 3-pole	722-133 /005-000/039-000
	Item no.: 722-134/005-000 Female connector for rail-mount terminal blocks; straight; 100% protected against mismatching; Pin spacing 5 mm; 4-pole	722-134 /005-000
	Item no.: 722-134/005-000/039-000 Female connector for rail-mount terminal blocks; straight; 100% protected against mismatching; Locking lever; Pin spacing 5 mm; 4-pole	722-134 /005-000/039-000
	Item no.: 722-135/005-000 Female connector for rail-mount terminal blocks; straight; 100% protected against mismatching; Pin spacing 5 mm; 5-pole	722-135 /005-000
	Item no.: 722-135/005-000/039-000 Female connector for rail-mount terminal blocks; straight; 100% protected against mismatching; Locking lever; Pin spacing 5 mm; 5-pole	722-135 /005-000/039-000
	Item no.: 722-136/005-000 Female connector for rail-mount terminal blocks; straight; 100% protected against mismatching; Pin spacing 5 mm; 6-pole	722-136 /005-000
	Item no.: 722-136/005-000/039-000 Female connector for rail-mount terminal blocks; straight; 100% protected against mismatching; Locking lever; Pin spacing 5 mm; 6-pole	722-136 /005-000/039-000
	Item no.: 722-137/005-000 Female connector for rail-mount terminal blocks; straight; 100% protected against mismatching; Pin spacing 5 mm; 7-pole	722-137 /005-000
	Item no.: 722-137/005-000/039-000 Female connector for rail-mount terminal blocks; straight; 100% protected against mismatching; Locking lever; Pin spacing 5 mm; 7-pole	722-137 /005-000/039-000
	Item no.: 722-138/005-000 Female connector for rail-mount terminal blocks; straight; 100% protected against mismatching; Pin spacing 5 mm; 8-pole	722-138 /005-000
	Item no.: 722-138/005-000/039-000 Female connector for rail-mount terminal blocks; straight; 100% protected against mismatching; Locking lever; Pin spacing 5 mm; 8-pole	722-138 /005-000/039-000
	Item no.: 722-139/005-000 Female connector for rail-mount terminal blocks; straight; 100% protected against mismatching; Pin spacing 5 mm; 9-pole	722-139 /005-000
	Item no.: 722-139/005-000/039-000 Female connector for rail-mount terminal blocks; straight; 100% protected against mismatching;	

	Locking lever; Pin spacing 5 mm; 9-pole	722-139 /005-000/039-000
	Item no.: 722-140/005-000 Female connector for rail-mount terminal blocks; straight; 100% protected against mismatching; Pin spacing 5 mm; 10-pole	722-140 /005-000
	Item no.: 722-140/005-000/039-000 Female connector for rail-mount terminal blocks; straight; 100% protected against mismatching; Locking lever; Pin spacing 5 mm; 10-pole	722-140 /005-000/039-000
	Item no.: 722-141/005-000 Female connector for rail-mount terminal blocks; straight; 100% protected against mismatching; Pin spacing 5 mm; 11-pole	722-141 /005-000
	Item no.: 722-142/005-000 Female connector for rail-mount terminal blocks; straight; 100% protected against mismatching; Pin spacing 5 mm; 12-pole	722-142 /005-000
	Item no.: 722-142/005-007/039-000 Female connector for rail-mount terminal blocks; straight; 100% protected against mismatching; Locking lever; Pin spacing 5 mm; 12-pole	722-142 /005-007/039-000
	Item no.: 722-143/005-000 Female connector for rail-mount terminal blocks; angled; 100% protected against mismatching; Pin spacing 5 mm; 13-pole	722-143 /005-000
	Item no.: 722-144/005-000 Female connector for rail-mount terminal blocks; straight; 100% protected against mismatching; Pin spacing 5 mm; 14-pole	722-144 /005-000
	Item no.: 722-144/005-000/039-000 Female connector for rail-mount terminal blocks; straight; 100% protected against mismatching; Locking lever; Pin spacing 5 mm; 14-pole	722-144 /005-000/039-000
	Item no.: 722-145/005-000 Female connector for rail-mount terminal blocks; straight; 100% protected against mismatching; Pin spacing 5 mm; 15-pole	722-145 /005-000
	Item no.: 722-146/005-000 Female connector for rail-mount terminal blocks; straight; 100% protected against mismatching; Pin spacing 5 mm; 16-pole	722-146 /005-000
	Item no.: 722-146/005-000/039-000 Female connector for rail-mount terminal blocks; straight; 100% protected against mismatching; Locking lever; Pin spacing 5 mm; 16-pole	722-146 /005-000/039-000
	Item no.: 722-150/005-000 Female connector for rail-mount terminal blocks; straight; 100% protected against mismatching; Pin spacing 5 mm; 20-pole	722-150 /005-000
	Item no.: 722-150/005-000/039-000 Female connector for rail-mount terminal blocks; straight; 100% protected against mismatching; Locking lever; Pin spacing 5 mm; 20-pole	722-150 /005-000/039-000
	Item no.: 722-232/005-000 Female connector for rail-mount terminal blocks; angled; 100% protected against mismatching; Pin	

	spacing 5 mm; 3-pole	722-232 /005-000
	Item no.: 722-232/005-000/039-000 Female connector for rail-mount terminal blocks; straight; 100% protected against mismatching; Locking lever; Pin spacing 5 mm; 3-pole	722-232 /005-000/039-000
	Item no.: 722-233/005-000 Female connector for rail-mount terminal blocks; angled; 100% protected against mismatching; Pin spacing 5 mm; 3-pole	722-233 /005-000
	Item no.: 722-233/005-000/039-000 Female connector for rail-mount terminal blocks; angled; 100% protected against mismatching; Locking lever; Pin spacing 5 mm; 3-pole	722-233 /005-000/039-000
	Item no.: 722-234/005-000 Female connector for rail-mount terminal blocks; angled; 100% protected against mismatching; Pin spacing 5 mm; 4-pole	722-234 /005-000
	Item no.: 722-234/005-000/039-000 Female connector for rail-mount terminal blocks; straight; 100% protected against mismatching; Locking lever; Pin spacing 5 mm; 4-pole	722-234 /005-000/039-000
	Item no.: 722-235/005-000 Female connector for rail-mount terminal blocks; angled; 100% protected against mismatching; Pin spacing 5 mm; 5-pole	722-235 /005-000
	Item no.: 722-235/005-000/039-000 Female connector for rail-mount terminal blocks; angled; 100% protected against mismatching; Locking lever; Pin spacing 5 mm; 5-pole	722-235 /005-000/039-000
	Item no.: 722-236/005-000 Female connector for rail-mount terminal blocks; angled; 100% protected against mismatching; Pin spacing 5 mm; 6-pole	722-236 /005-000
	Item no.: 722-236/005-000/039-000 Female connector for rail-mount terminal blocks; angled; 100% protected against mismatching; Locking lever; Pin spacing 5 mm; 6-pole	722-236 /005-000/039-000
	Item no.: 722-237/005-000 Female connector for rail-mount terminal blocks; angled; 100% protected against mismatching; Pin spacing 5 mm; 7-pole	722-237 /005-000
	Item no.: 722-237/005-000/039-000 Female connector for rail-mount terminal blocks; angled; 100% protected against mismatching; Locking lever; Pin spacing 5 mm; 7-pole	722-237 /005-000/039-000
	Item no.: 722-238/005-000 Female connector for rail-mount terminal blocks; angled; 100% protected against mismatching; Pin spacing 5 mm; 8-pole	722-238 /005-000
	Item no.: 722-239/005-000 Female connector for rail-mount terminal blocks; angled; 100% protected against mismatching; Pin spacing 5 mm; 9-pole	722-239 /005-000
	Item no.: 722-239/005-000/039-000 Female connector for rail-mount terminal blocks; angled; 100% protected against mismatching;	

	Locking lever; Pin spacing 5 mm; 9-pole	722-239 /005-000/039-000
	Item no.: 722-240/005-000 Female connector for rail-mount terminal blocks; angled; 100% protected against mismatching; Pin spacing 5 mm; 10-pole	722-240 /005-000
	Item no.: 722-240/005-000/039-000 Female connector for rail-mount terminal blocks; angled; 100% protected against mismatching; Locking lever; Pin spacing 5 mm; 10-pole	722-240 /005-000/039-000
	Item no.: 722-241/005-000 Female connector for rail-mount terminal blocks; straight; 100% protected against mismatching; Pin spacing 5 mm; 11-pole	722-241 /005-000
	Item no.: 722-242/005-000 Female connector for rail-mount terminal blocks; angled; 100% protected against mismatching; Pin spacing 5 mm; 12-pole	722-242 /005-000
	Item no.: 722-242/005-000/039-000 Female connector for rail-mount terminal blocks; angled; 100% protected against mismatching; Locking lever; Pin spacing 5 mm; 12-pole	722-242 /005-000/039-000
	Item no.: 722-243/005-000 Female connector for rail-mount terminal blocks; angled; 100% protected against mismatching; Pin spacing 5 mm; 13-pole	722-243 /005-000
	Item no.: 722-244/005-000 Female connector for rail-mount terminal blocks; angled; 100% protected against mismatching; Pin spacing 5 mm; 14-pole	722-244 /005-000
	Item no.: 722-244/005-000/039-000 Female connector for rail-mount terminal blocks; angled; 100% protected against mismatching; Locking lever; Pin spacing 5 mm; 14-pole	722-244 /005-000/039-000
	Item no.: 722-246/005-000 Female connector for rail-mount terminal blocks; angled; 100% protected against mismatching; Pin spacing 5 mm; 16-pole	722-246 /005-000
	Item no.: 722-246/005-000/039-000 Female connector for rail-mount terminal blocks; angled; 100% protected against mismatching; Locking lever; Pin spacing 5 mm; 16-pole	722-246 /005-000/039-000
	Item no.: 722-250/005-000 Female connector for rail-mount terminal blocks; angled; 100% protected against mismatching; Pin spacing 5 mm; 20-pole	722-250 /005-000
assembling		
	Item no.: 209-106 Mounting carrier; for isolated mounting on DIN 35 rails	209-106
	Item no.: 709-153 Cover; Type 1; suitable for cover carrier, type 1; 1 m long	709-153
check		
	Item no.: 249-141 L-type test plug module; modular; with spring-loaded contact pin; Center module	249-141

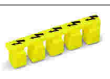
tools		
	Item no.: 210-657 Operating tool with partially insulated shaft; Blade (3.5 x 0.5) mm; short	210-657
	Item no.: 210-658 Operating tool with partially insulated shaft; Blade (3.5 x 0.5) mm; short; angled	210-658
	Item no.: 210-720 Operating tool with partially insulated shaft; Type 2, blade (3.5 x 0.5) mm	210-720
ferrule		
	Item no.: 216-101 Ferrule; Sleeve for 0.5 mm ² / AWG 22; uninsulated; electro-tin plated	216-101
	Item no.: 216-102 Ferrule; Sleeve for 0.75 mm ² / AWG 20; uninsulated; electro-tin plated	216-102
	Item no.: 216-103 Ferrule; Sleeve for 1 mm ² / AWG 18; uninsulated; electro-tin plated	216-103
	Item no.: 216-104 Ferrule; Sleeve for 1.5 mm ² / AWG 16; uninsulated; electro-tin plated	216-104
	Item no.: 216-201 Ferrule; Sleeve for 0.5 mm ² / 20 AWG; insulated; electro-tin plated	216-201
	Item no.: 216-202 Ferrule; Sleeve for 0.75 mm ² / 18 AWG; insulated; electro-tin plated	216-202
	Item no.: 216-203 Ferrule; Sleeve for 1 mm ² / AWG 18; insulated; electro-tin plated	216-203
	Item no.: 216-204 Ferrule; Sleeve for 1.5 mm ² / AWG 16; insulated; electro-tin plated	216-204
	Item no.: 216-301 Ferrule; Sleeve for 0.25 mm ² / AWG 24; insulated; electro-tin plated	216-301
	Item no.: 216-302 Ferrule; Sleeve for 0.34 mm ² / 22 AWG; insulated; electro-tin plated	216-302
End plate		
	Item no.: 280-316 End and intermediate plate; 2.5 mm thick	280-316
	Item no.: 280-317 End and intermediate plate; 2.5 mm thick	280-317
	Item no.: 280-327 Separator plate; 2 mm thick; oversized	280-327
	Item no.: 280-337 Separator plate; 2 mm thick; oversized	280-337
Protective Warning Marker		
	Item no.: 280-415 Protective warning marker; with high-voltage symbol, black; for 5 terminal blocks	280-415



Downloads

CAD/CAE - Smart Data

CAD data

3D Download 280-624/281-434

URL

Download

Subject to changes.
